

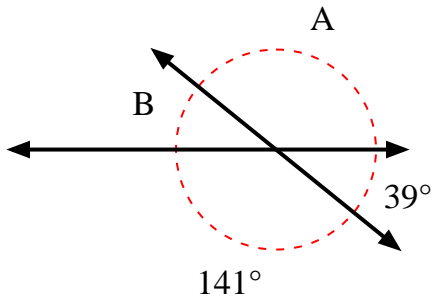

Find the value of angle 'A' and angle 'B'.

1)



2)

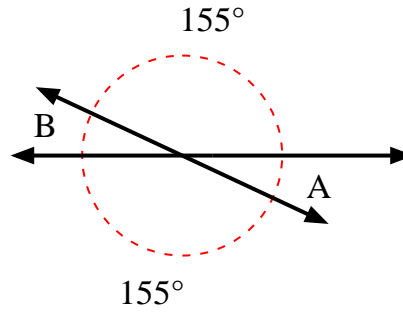

3)

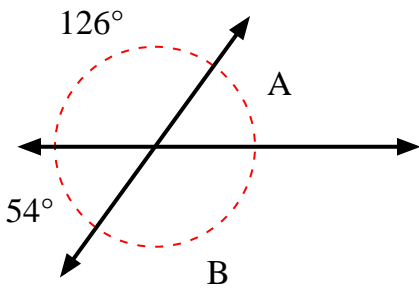

4)

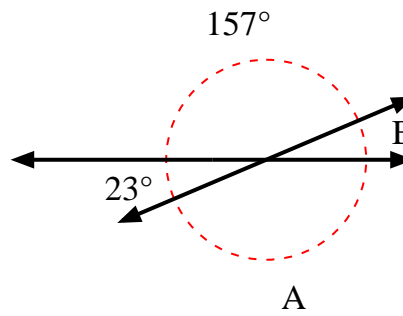

5)

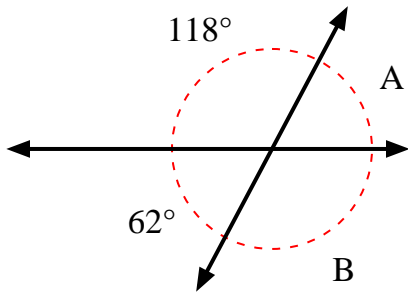

6)

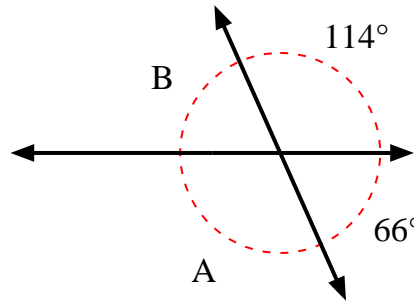

7)

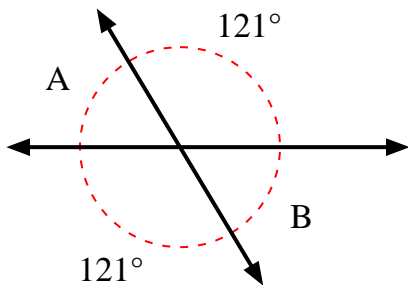

8)

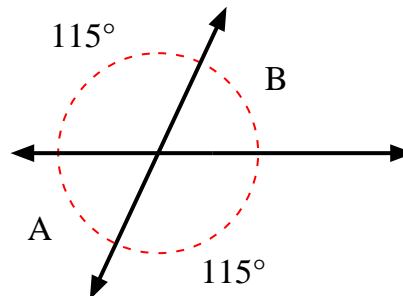

Answers

1. _____
2. _____
3. _____
4. _____
5. _____
6. _____
7. _____
8. _____



Find the value of angle 'A' and angle 'B'.

1)

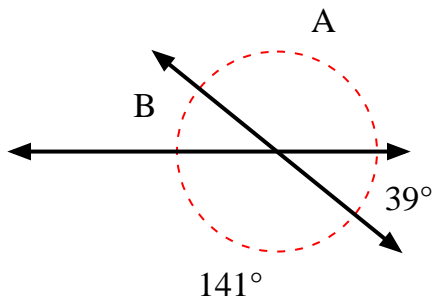

2)

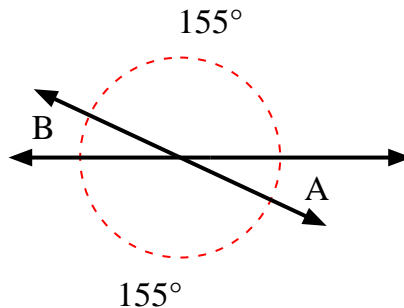

3)

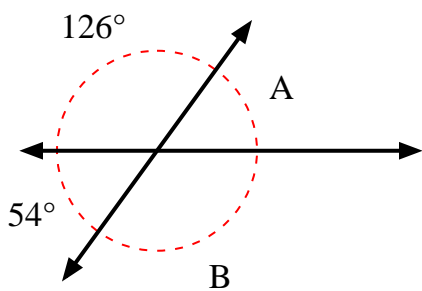

4)

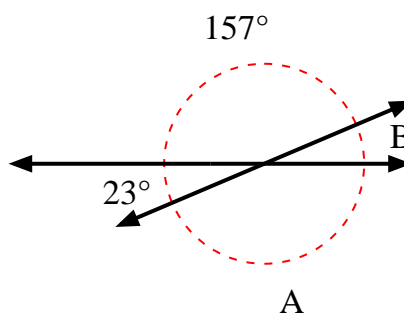

5)

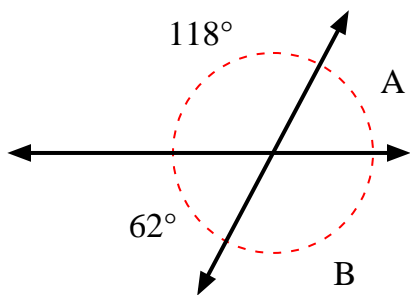

6)

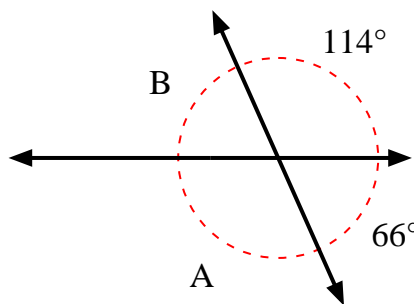

7)

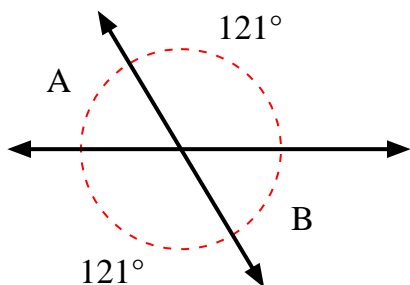

8)

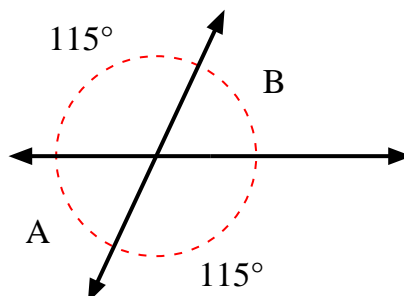

Answers

- | | | |
|----|-------------|-------------|
| 1. | 141° | 39° |
| 2. | 25° | 25° |
| 3. | 54° | 126° |
| 4. | 157° | 23° |
| 5. | 62° | 118° |
| 6. | 114° | 66° |
| 7. | 59° | 59° |
| 8. | 65° | 65° |